

# R120103080

Lv4-2025-r1

Modelo-model:

## FIRRAK ancora kit

Lote-Lot-Lot-Lot:

**01-25**

Peso-Weight-Poids-Gewicht:

**1,46 kg / 3,22 lbs**

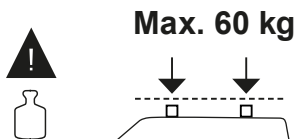
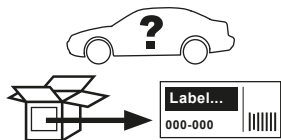

CEE - EEC type approval:

**E9** 26 R- 04 3015

ES	<b>Instrucción de montaje</b> ¡Leer primero!	Kit de fijación
EN	<b>Assembly instructions</b> Read first!	Fixation kit
FR	<b>Instruction de montage</b> Lire en premier!	Kit fixation
DE	<b>Montageanleitung</b> Zuerst lesen!	Stützfuß-Kit

1

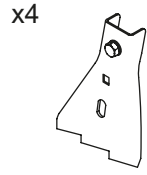
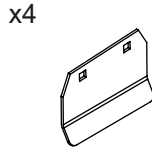
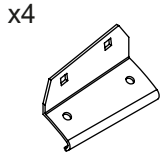
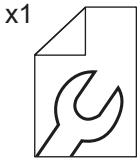
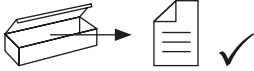

1x (2831)  
1x (2833)  
1x (2835)  
1x (2837)

1x (2832)  
1x (2834)  
1x (2836)  
1x (2838)

(815-300)

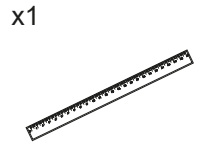
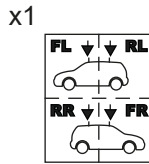
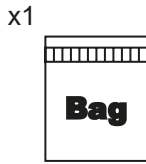
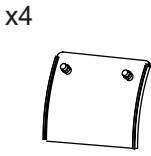

(012-040)

(810-052)

(018-041)

(001-823)

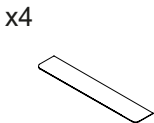

(018-099)



**Importante!**  
**Important!**  
**Important!**  
**Wichtig!**

- ES ¡Este Kit de fijación tiene que usarse con sistemas portacargas FIRRAK!
- EN This fixation Kit must be used with FIRRAK roof rack systems!
- FR Cet Kit de fixation devra être utilisé avec les systèmes porte-charge FIRRAK!
- DE Dieser Stützfuß-Kit muß mit FIRRAK Dachträgersystemen benutzt werden!

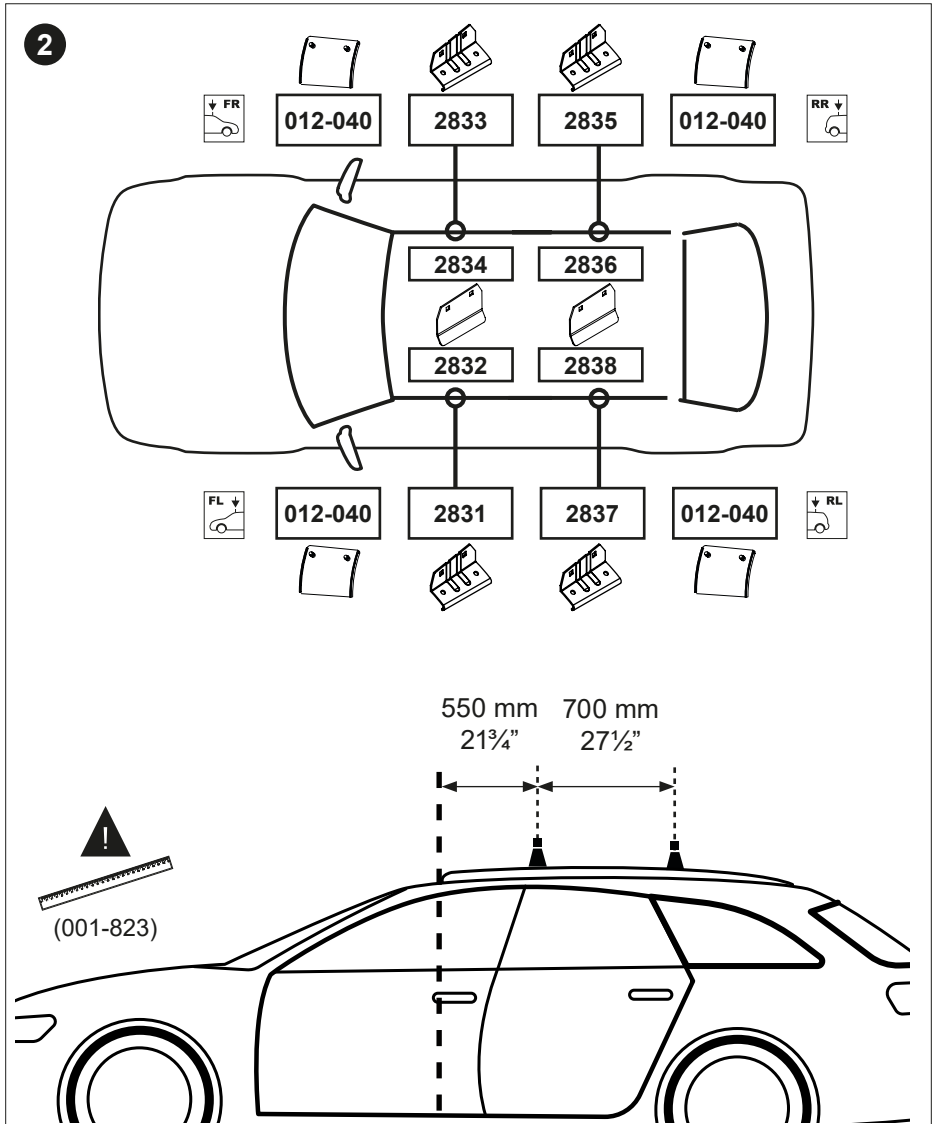
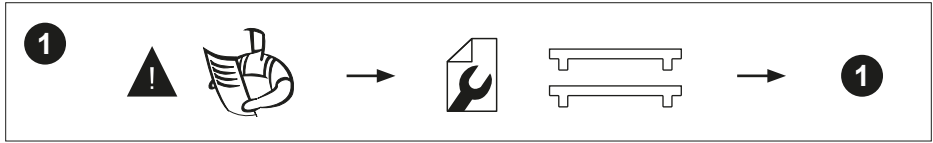

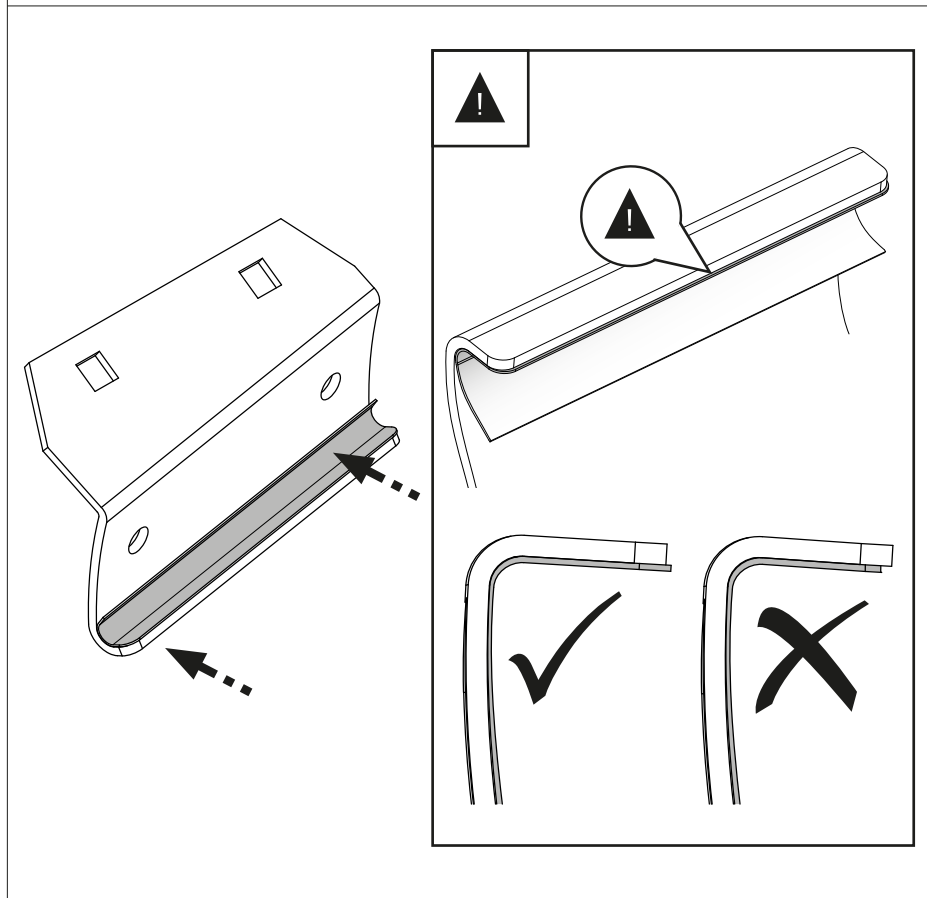
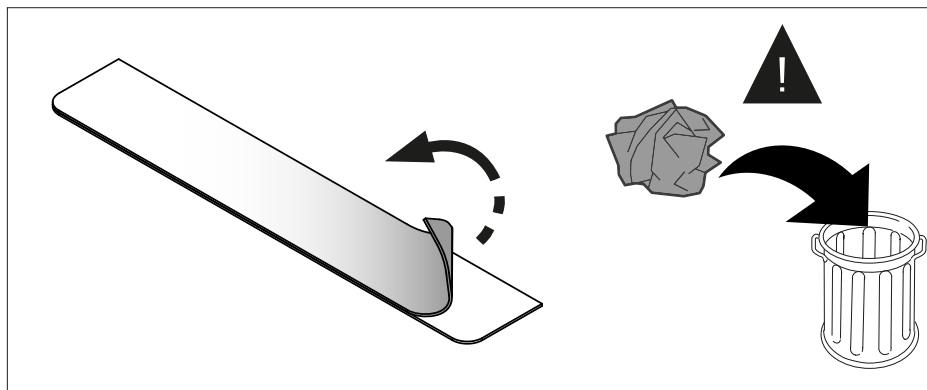

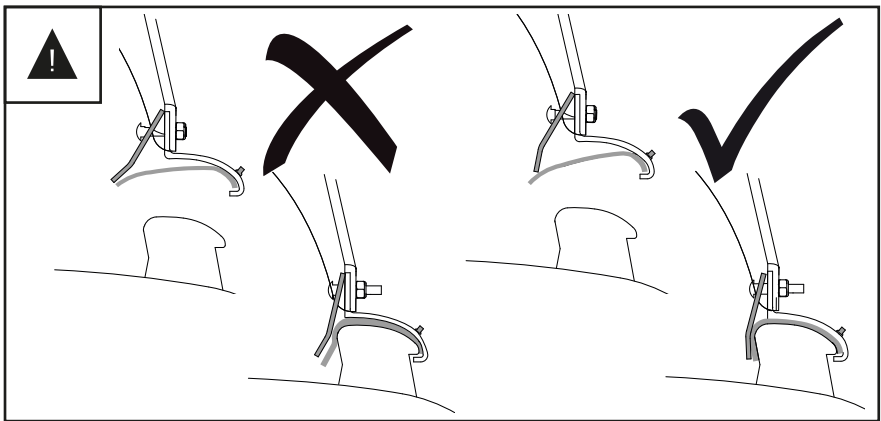
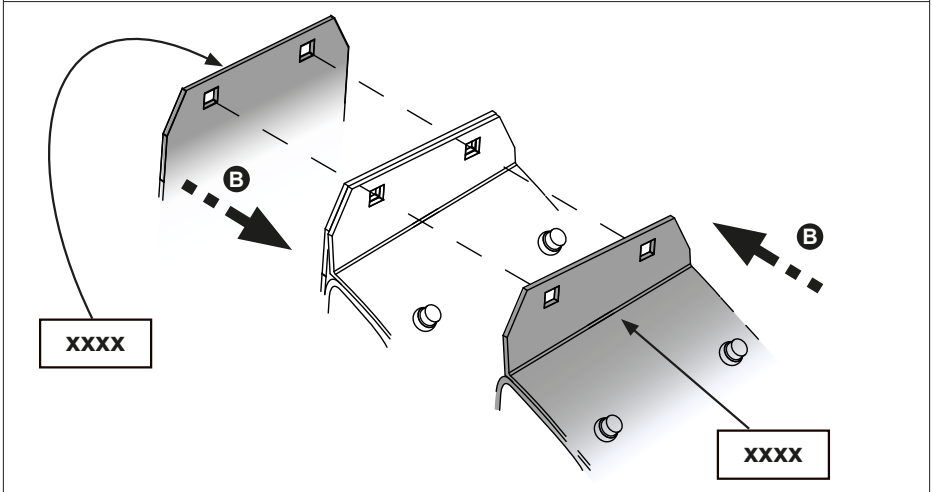
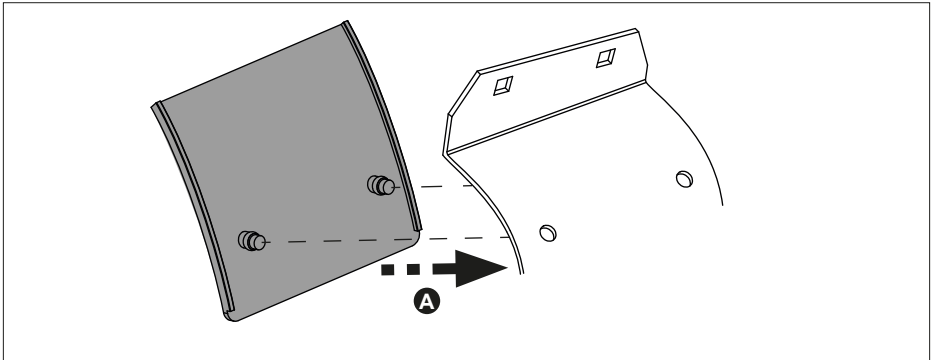

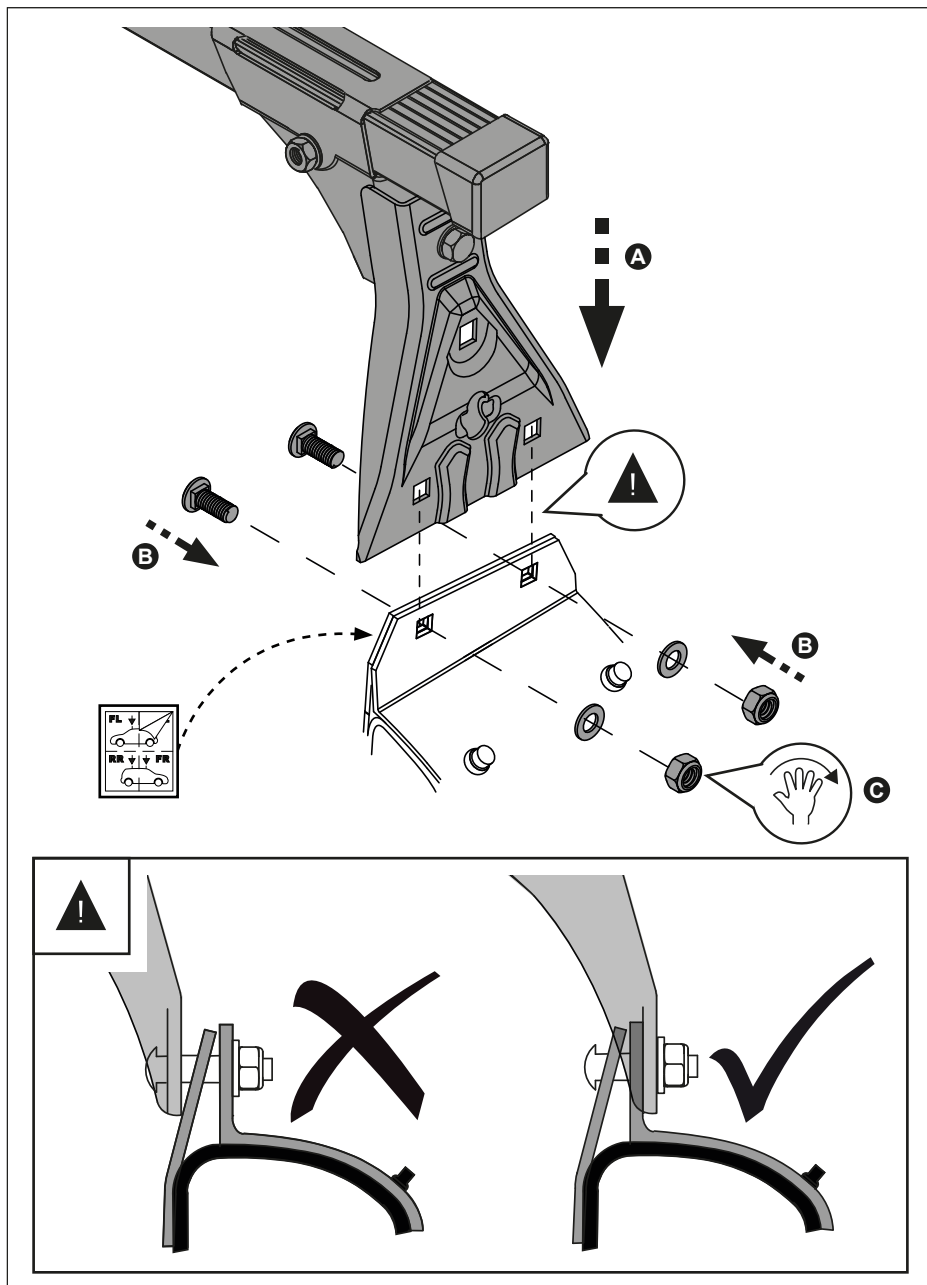

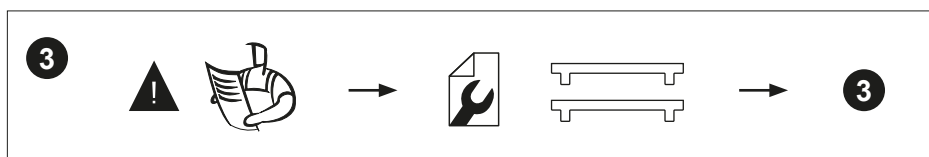
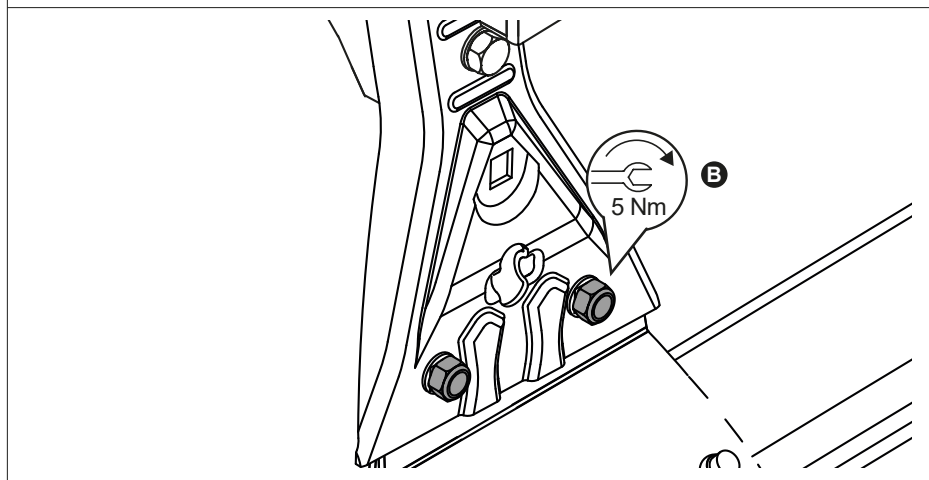
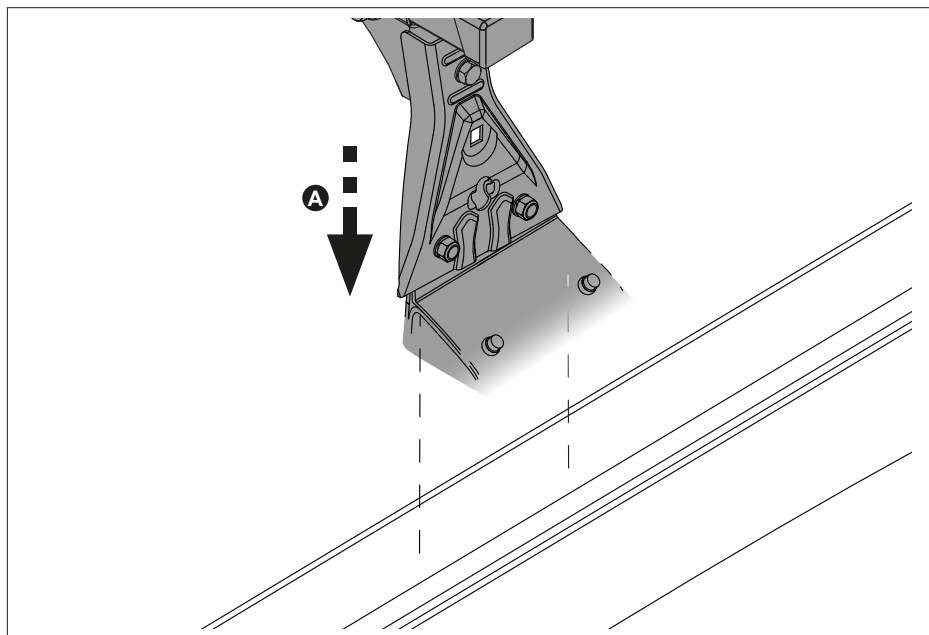



CRUZBER SAU  
ES-A14018311  
Pol.Ind. Las Salinas II  
14960 - Rute - Spain

[www.firrak.com](http://www.firrak.com)