













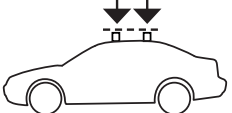

Cruzber S.A., ES-A14018311
P.I. Las Salinas II, E-14960 Rute
www.cruzber.com





- (E)** **Instrucción de montaje:**
¡Leer primero!
- (GB)** **Assembly instructions:**
Read first!
- (F)** **Instruction de montage:**
Lire en premier!
- (D)** **Montageanleitung:**
Zuerst lesen!
- (PT)** **Instruções de montagem:**
Ler primeiro!
- (PL)** **Instrukcja montażu:**
Najpierw przeczytaj!
- (CZ)** **Montážní návod:**
Čtěte pozorně!
- (HU)** **Szerelési Utasítás:**
Először olvassd el!
- (RO)** **Instructiuni de montaj:**
Intai cititi!
- (HR)** **Detaljne upute**
Prvo pročitati!
- (GR)** **Διαβάστε προσεκτικά τις:**
Οδηγίες Συναρμολόγησης!
- (TR)** **Öncelikli montaj:**
Talimatlarını okuyunuz!
- (RU)** **Инструкции по монтажу:**
Сначала прочитайте!
- (IT)** **Istruzioni di montaggio**
Leggere per primo!

- Kit fijación
- Fixation Kit
- Kit fixation
- Stützfuß-Kit
- Kit fixação
- Element mocujący
- Fixační kit
- Rögzítő készlet
- Kit de fixare
- Kit za montažu
- Κιβώτιο (Kit) Επισκευής
- Montaj kiti
- Крепежный комплект
- Kit di fissaggio

Código Code Code Code	931-066		
	Lv 5 2011 - r 4		
Lote Lot Lot Lot	03-07	Peso Weight Poids Gewicht	0,94 kg
  			
 		Max: 50 kg	
			
Código Homologación CEE EEC Type Approval Number		e9*74/483*87/354*3017	

	1°		
	2°		
			

- (E)** **Contenido embalaje:** ¡Verificar!
- (GB)** **Package content:** Check!
- (F)** **Contenu d'emballage:** Vérifier!
- (D)** **Packungsinhalt:** Überprüfen!
- (PT)** **Contéudo embalagem:** Verificar!
- (PL)** **Zawartość opakowania:** sprawdzić!
- (CZ)** **Obsah balení:** Zkontrolujte!
- (HU)** **Csomag tartalma:** Ellenőrizd!
- (RO)** **Pachetul contine:** Verificati!
- (HR)** **Sadržaj paketa:** Provjeri!
- (GR)** **Ελέγξτε το περιεχόμενο:** του πακέτου!
- (TR)** **Paket içeriğini:** Control ediniz!
- (RU)** **Содержание упаковки:** Проверьте!
- (IT)** **Contenuto della confezione:** Controllare!

x 1 	x 1 	x 1  (018-041)	x 4  2x (815-367) 2x (815-368)
x 4  (813-002)			

Código
Code
Code
Kode

931-066

Lv 5 2011 - r 4



Importante!
Important!
Important!
Wichtig!

- E** ¡Este Kit de fijación tiene que usarse con sistemas portacargas Cruz!
- GB** This fixation Kit must be used with Cruz roof rack systems!
- F** Cet Kit de fixation devra être utilisé avec les systèmes portecharge Cruz!
- D** Dieser Stützfuß-Kit muß mit Cruz Dachträgersystemen benutzt werden!
- PT** Este Kit de fixação deve ser utilizado com os sistemas porta cargas Cruz!
- PL** Niniejszy element mocujący musi być używany z systemami bagażników dachowych firmy Cruz!
- CZ** Tento fixační kit musí být používán s nosným systémem Cruz!
- HU** Ez a rögzítő készlet csak a Cruz rendszerekkel használható!
- RO** Acest Kit de fixare, trebuie utilizat cu sisteme Cruz!
- HR** Kit za montažu mora biti korišten uz Cruz sistem krovnog nosača!
- GR** Το αξεσουάρ αυτό θα πρέπει να χρησιμοποιείται αποκλειστικά στα συστήματα μπαρών της Cruz!
- TR** Bu aksesuar mutlaka Cruz taşıma sistemleriyle kullanılmalıdır!
- RU** Крепежный комплект должен быть использован с багажной системой на крышу марки Cruz!
- IT** Questo accessorio deve essere usato con i portapacchi Cruz!

1

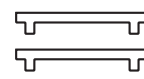

1

2

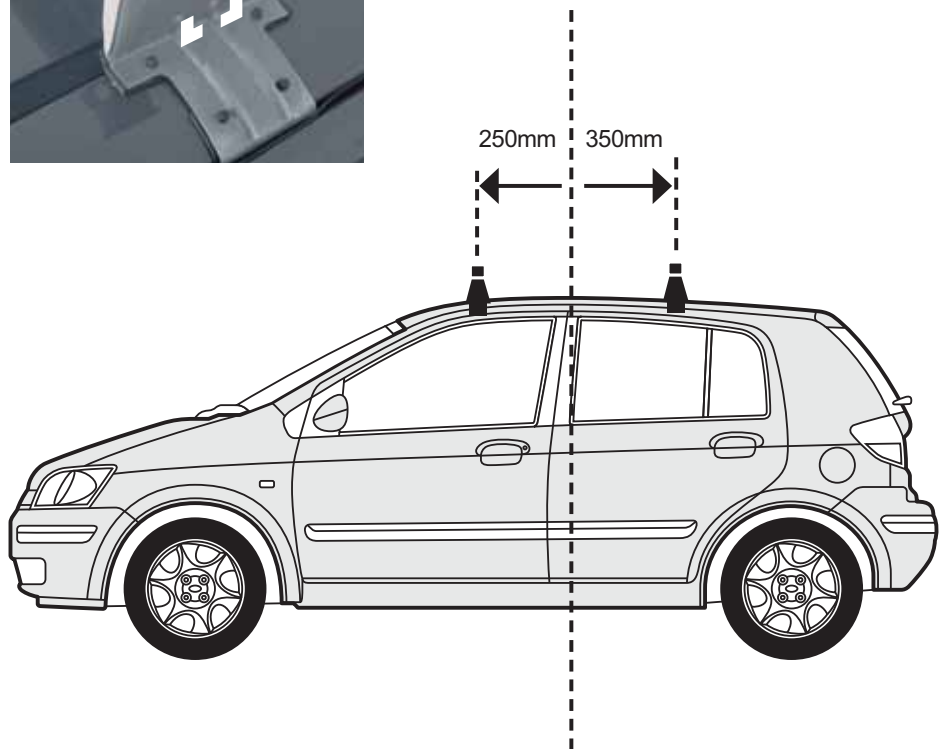
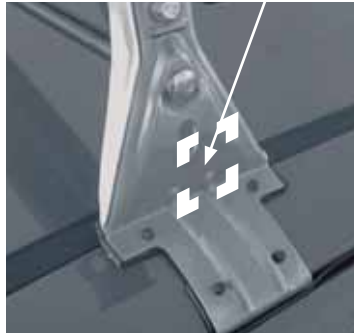
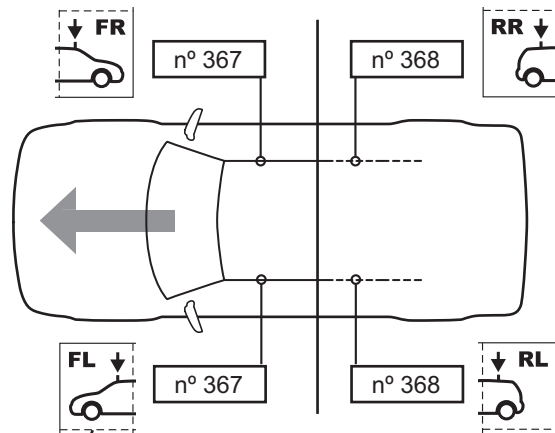

3

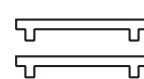

3